

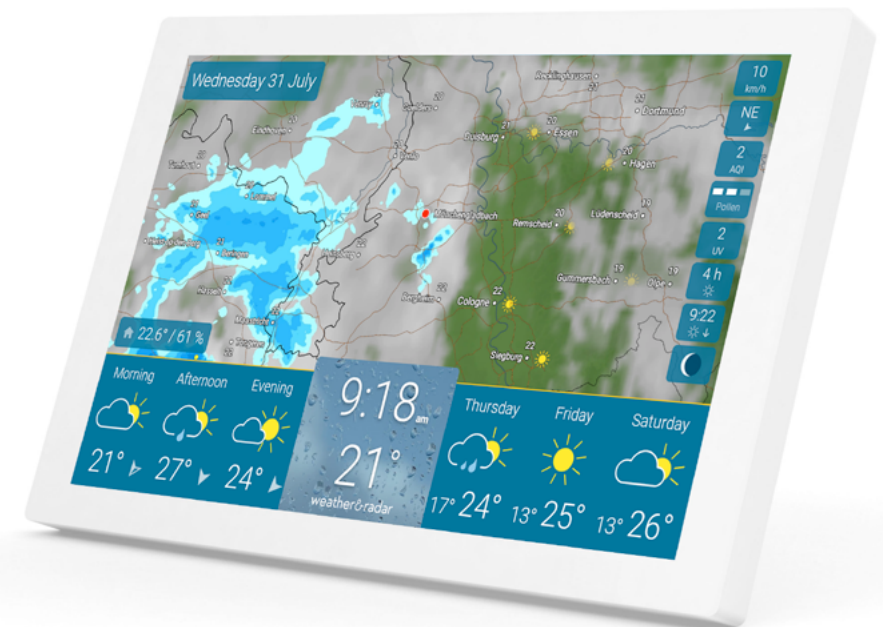

Contents

Set up – Ready to go	3
Display – Where is what?	4
WeatherRadar – Live for the next 90 minutes	4
Weather during the day, current temperature, and WeatherTrend	5
Detailed Weather	6
14-day weather	7
Severe weather warnings	8
Integrated indoor climate sensor	9
Pollen count	11
UV index	11
Air quality index	12
Astro info	12
More weather data	13
Settings	14
Brightness, zoom function & other settings	14
Set screen times	15
My location	16
Info	17
Wi-Fi	18
System	19
Language & units	20
Advanced settings	21

Standby	22
Technical details	23
Reset	24
Important notes & contact	25



This is how you set up your weather&radar home device.



1. Connect the device to a power outlet.

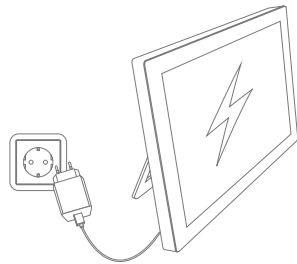

2. Establish a Wi-Fi connection.



3. Automatic localization:
The weather for your current location is displayed.

Establish a Wi-Fi connection

Automatic localization



WeatherRadar – Live for the next 90 minutes

The upper part of the screen shows the WeatherRadar for your location.

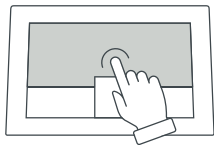

By tapping the map, you start a film that shows the weather's development in the next 90 minutes. Tap again to stop the film. The WeatherRadar is automatically updated every 5 minutes.

How to use the zoom function is explained on [page 14](#).

WeatherRadar

The WeatherRadar map shows sun, clouds, precipitation as well as lightning.

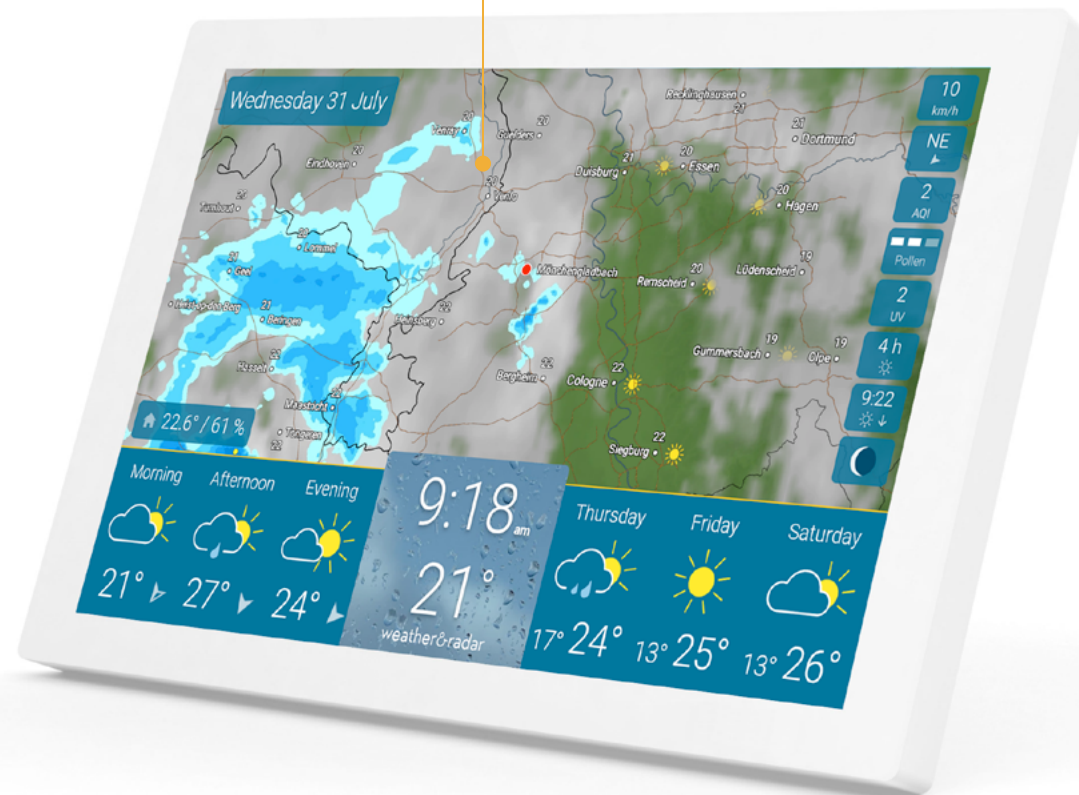

Tip

To pause the radar film at any point, tap and hold the radar image.

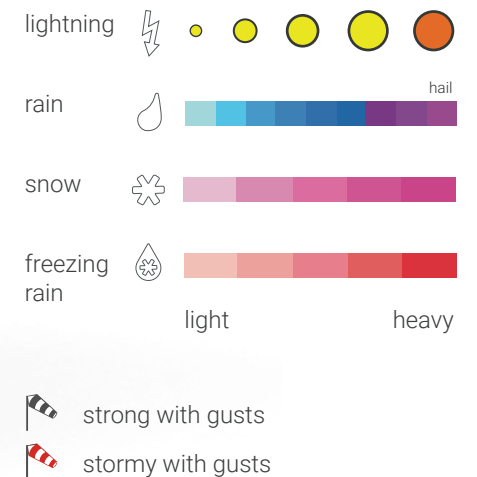

Weather during the day, current temperature, and WeatherTrend

The lower part of the screen shows the daily weather on the left-hand side and the WeatherTrend of the upcoming days on the right. In the middle of the screen, the current time and temperature are displayed.

Current temperature and time
The time and the current temperature are presented in large letters in the center of the forecast bar. The background image shows the weather of the next hour.

Tip

Click and hold the clock to open the settings.



Current indoor temperature and humidity

Weather today

The forecast for the three following times of the day is indicated in the left section of the forecast bar.

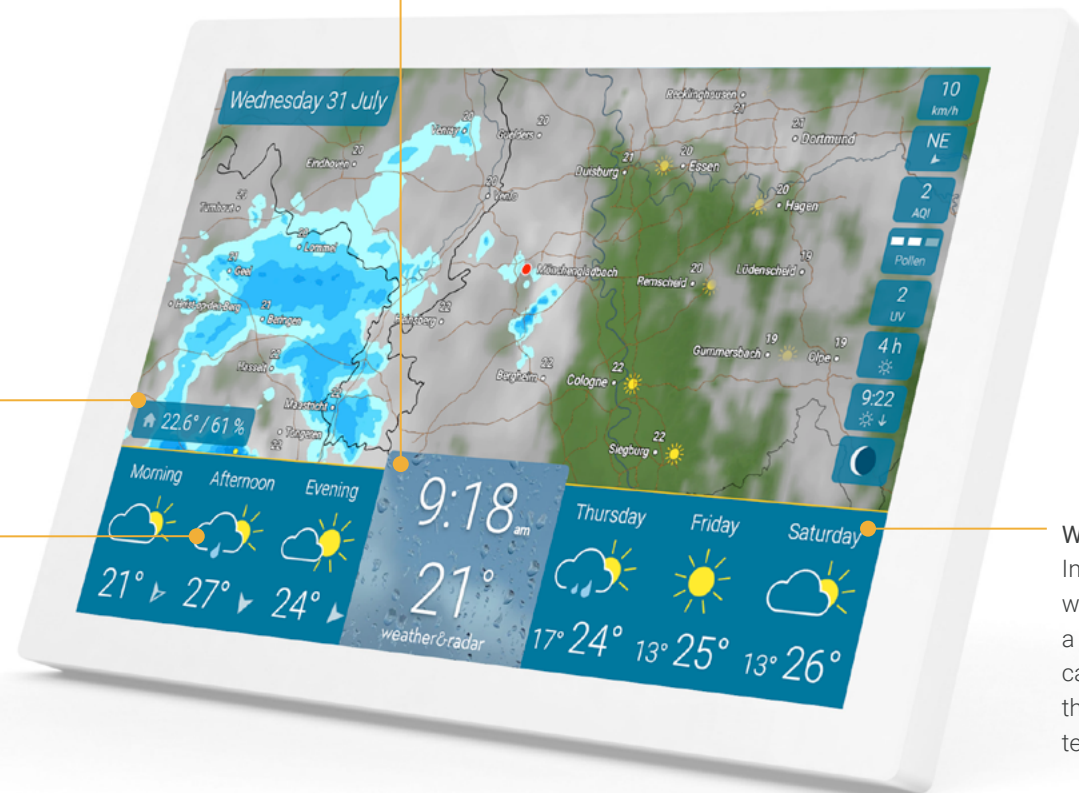

WeatherTrend

In the right section of the forecast, the weather of the next three days is shown by a forecast symbol. Below the symbol, you can see the expected daily highs. In between, there are the expected nightly minimum temperatures.

Detailed Weather

Day weather

When tapping on an individual day, the weather of the day's sections is displayed including sunshine duration, probability of rain, and, if applicable, rain duration and amount.

Hourly weather

Tap on an individual day segment to see the hourly forecast including temperature and wind.



Tip

Navigate through different views by swiping left or right.



14-day weather

By pressing 'Trend'– in the top right corner of the hourly or daily forecast – you see the projected weather and temperature development for the next 14 days.

14-day weather



Tip

Swipe from right to left over the three forecast days on the home screen to quickly access the 14-day trend.

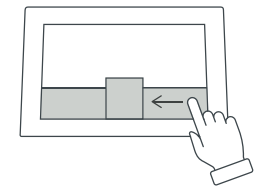



Severe weather warnings for thunderstorms, storms, icy roads, and rain

In the event of impending severe weather, a weather alert is displayed in the top left part of the screen. Depending on the severity of the inclement weather, an additional warning symbol appears.

lightning ⚡ ● ● ● ● ●

rain ☔  hail

snow ❄️ 

freezing rain ❄️  light heavy

 strong with gusts

 stormy with gusts

Tip

With a tap on the warning, you can open the warning map and see the extent of the severe weather.



Severe weather warning

Warning map

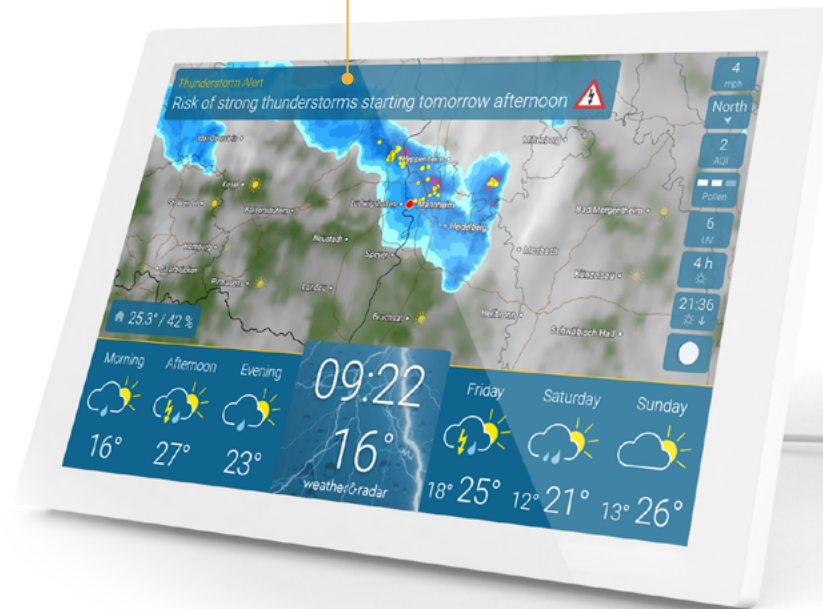

Integrated indoor climate sensor

A sensor integrated into the device measures room temperature and humidity. This information helps to control the indoor climate and regulate the temperature efficiently. You can tell at a glance whether your home is too humid, too dry or just right. A value of 40 to 60 percent humidity is usually considered optimal.

Current temperature and relative humidity at the location of weather & radar home

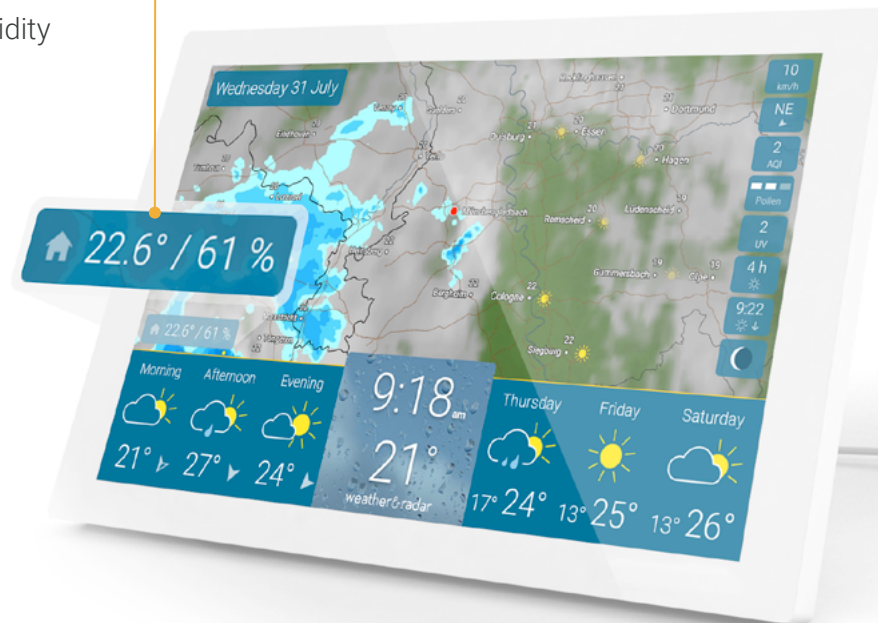

Evaluation of the indoor climate



Integrated indoor climate sensor

The history provides you with an overview of the past 48 hours and helps you to recognize, for example, when it is best to air out the room.



Tip

Swipe over the values at the bottom left to go directly to the history page.

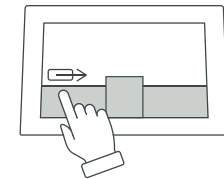

Pollen count

For allergy sufferers, detailed information on pollen count and a pollen calendar are available. These facilitate both, short-term and long-term planning.

UV index

The UV index is displayed not only for the current day, but also for the next six days. The levels range from “low” to “extreme” and provide an indication of what measures should be taken to protect against harmful UV radiation.



Air quality index

The air quality index helps you to decide whether you can spend a long time outside today or whether there are a lot of pollutants in the air. The forecast makes it easier to plan for the next four days.

Astro info

The Astro info shows the rising and setting times for the sun and moon, the moon phase and the hours of sunshine. The values for the next five days can also be displayed with a swipe to the left.



More weather data

Here you can select the display of up to 8 additional weather data next to the weather map.

Current values

- wind speed and gusts
- wind direction
- relative humidity
- air pressure incl. tendency
- 'Feels like' temperature

Daily values

- pollen count
- UV index
- air quality index
- sunrise/sunset times
- moon phases
- sunshine hours

Select additional weather data

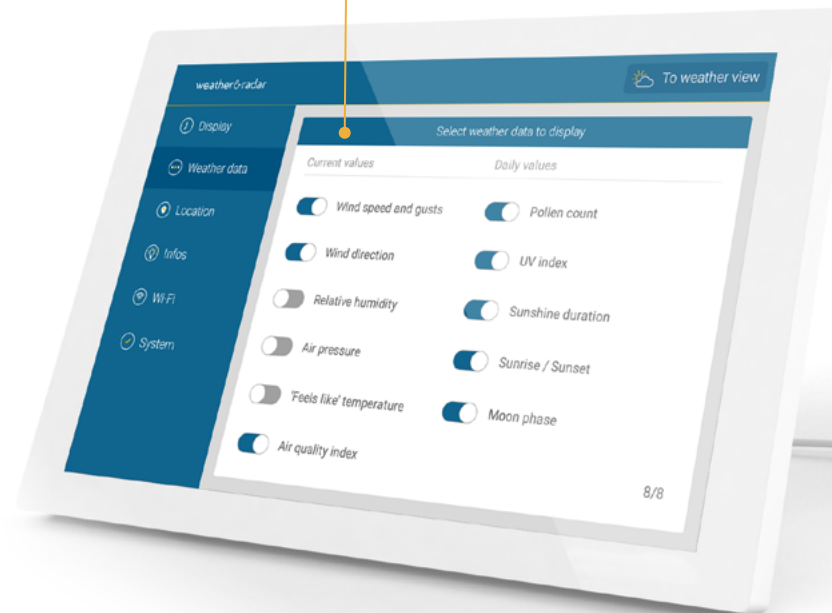

Additional weather data on display

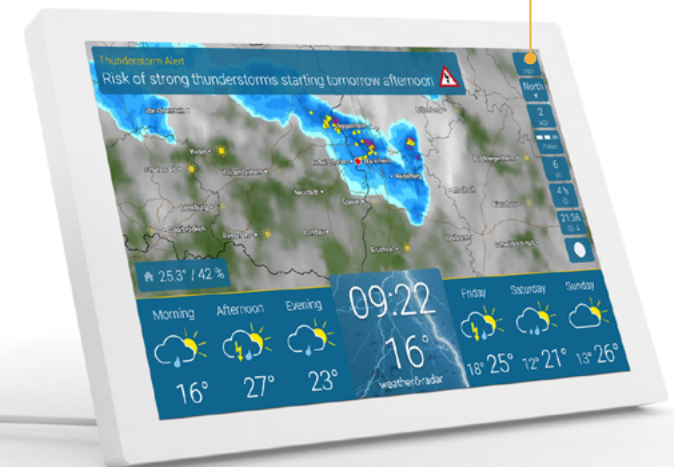

Tip

Tap on **sunrise** or **sunset** to see the respective other event.



Brightness, zoom function & other settings

When tapping the center of the forecast bar, a brightness slider appears on the bottom left side, the regulator for the zoom function of the weather map in the center, and advanced settings at the bottom right side of the screen.

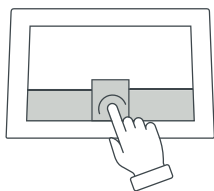

The screen brightness is automatically reduced gradually after sunset. (see [page 21](#) for details)

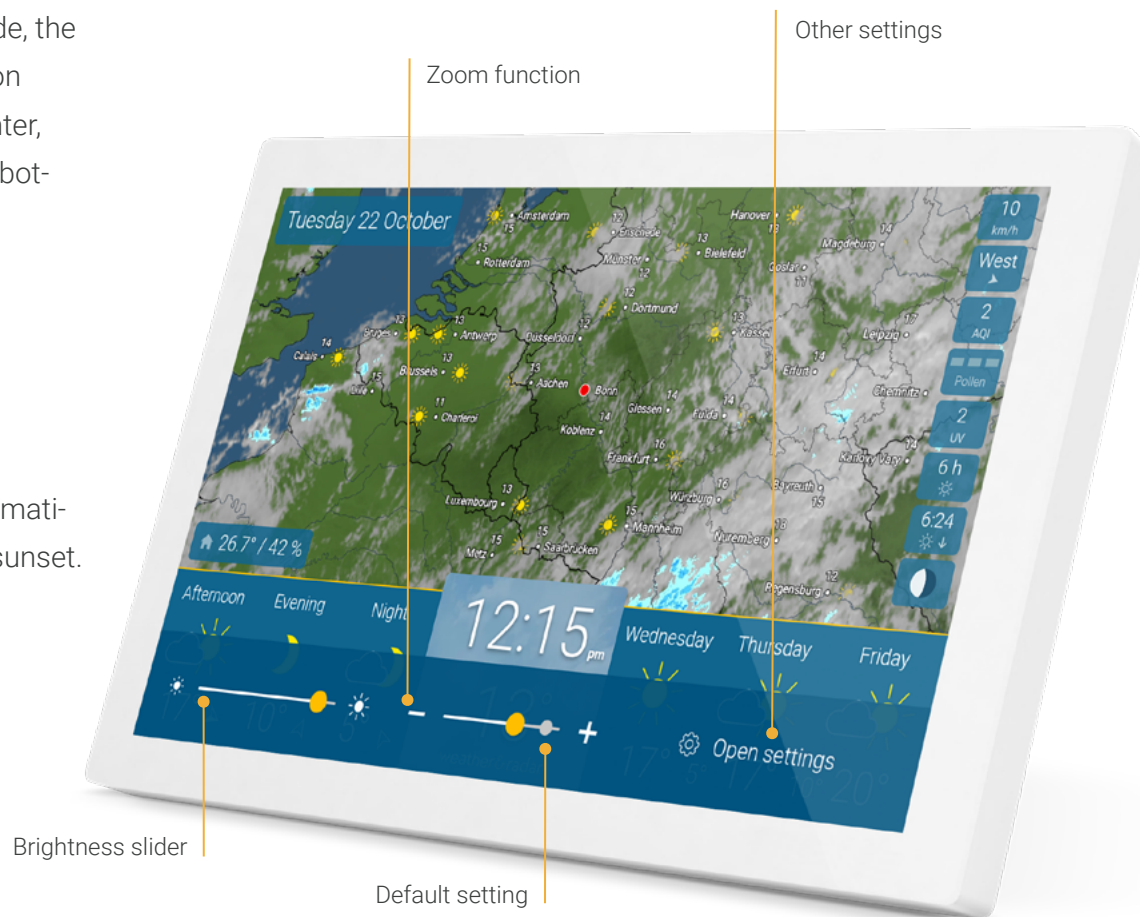

Tip

Swipe left or right on the map to play the weather clip forwards or backwards.



Tip

To set the scale of the weather map, use the '+' and '-' buttons, the slider, or pinch your thumb and pointer finger together or apart.

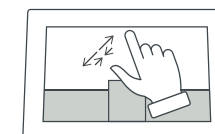

Set screen times

Under the item 'Display' in the settings menu, you can set specific times at which the device should be on standby or be active. Times can also be set for different days. You can define your own rules for this.

The default operating time of the device is from 6 am to 11 pm.

Tip

Days can also be selected or deselected in the overview.



Set screen times

Add new rules or edit existing rules



My location

When starting the device, your location is automatically determined. Optionally, you can specify a different location for the WeatherRadar and the weather data under the menu item 'Location'.

The last three searched locations are shown below the search bar. Click and hold to remove them from your view. You can also always turn back on automatic localization in this menu.

Enter a location

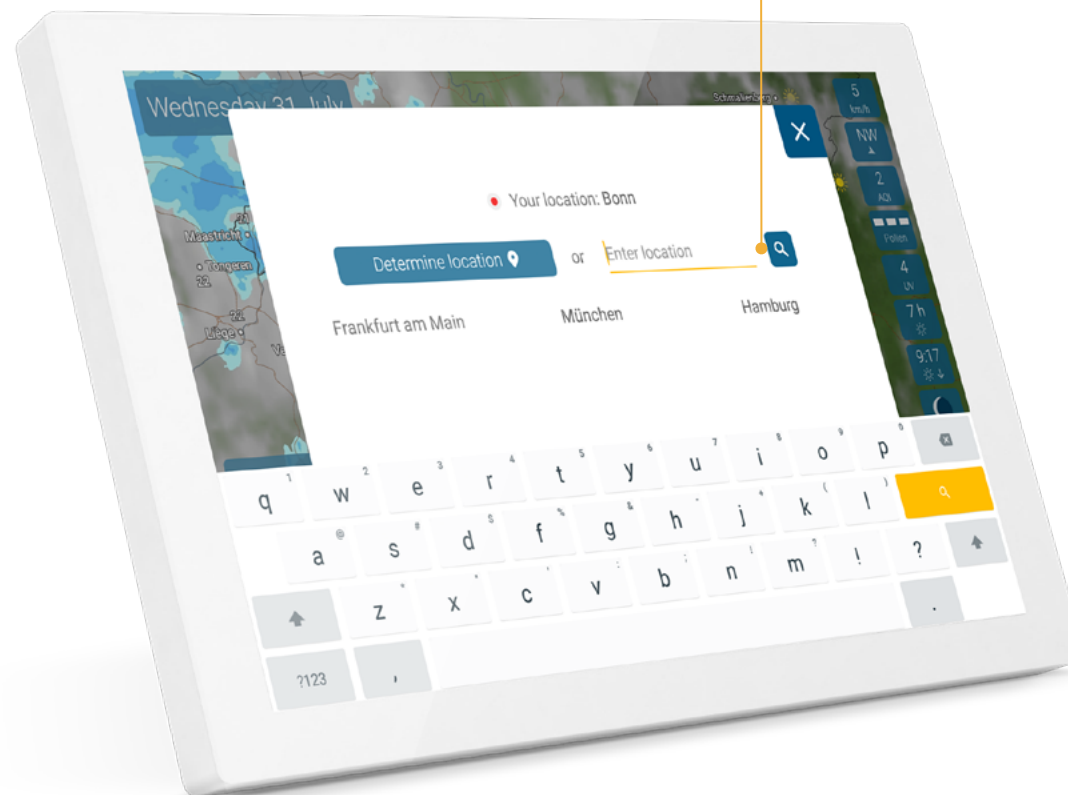

Tip

By tapping on the red dot in the center of the WeatherRadar you are forwarded to 'Location' much faster.



Info

By tapping on the menu item 'Info', the weather legend appears on the right.

Besides, you are directed to a short introduction tour that shows you all the basic functions of the device.



Wi-Fi

During the initial setup of your device, you are automatically asked to establish a connection to the internet. You can change this any time under the menu item 'Wi-Fi'.

First aid for Wi-Fi connection

- Briefly disconnect your router and restart your device. Attention! It must be a 2.4 GHz network.
- If issues persist: Connect your device with a guest Wi-Fi network or a mobile phone hotspot.
- Please check if the latest software is installed on your device. Tap on 'System' in the settings and then on the version number.

Tip

Visit our **help section** by tapping a Wi-Fi network in the list and then the **help button**.



System

This menu point contains systemrelevant information and functions, such as the current software version, the MAC address of the device, data privacy information as well as the option to restart or reset the device.

Have a look at our protocol in the menu item 'Changelog' to stay informed about the latest features and improvements.

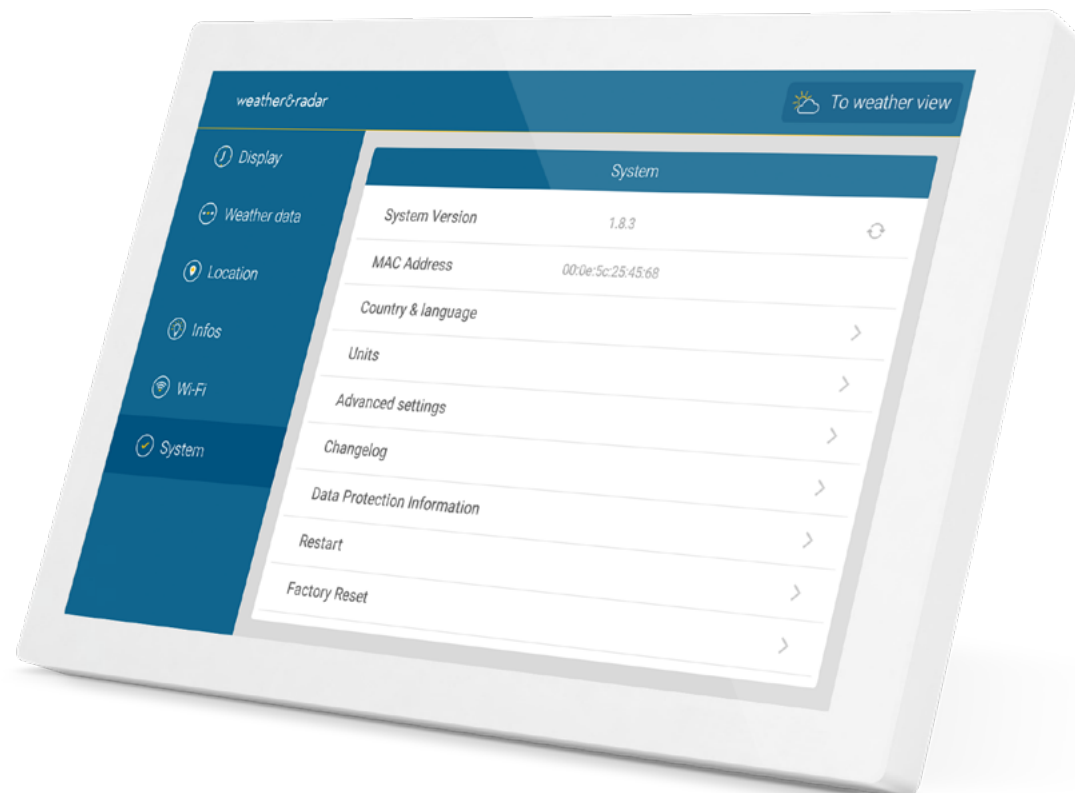

Language & units

Select the country and the display language in which you want to use weather & radar home under the menu point 'System'. These settings affect the appearance and the units used.

Under the menu item 'Units' you can further adjust the display to your needs:

- display of the time: 12 or 24-hour format
- temperature unit: Celsius or Fahrenheit
- distance and speed: metric or imperial
- distance and speed: metric or imperial
- wind unit: km/h, m/s, Bft, mph
- air pressure unit: hPA, inHg, mmHg



Tip

Instead of the relative humidity, the dew point can be displayed in the additional weather data ([see page 13](#)).

Advanced settings

Here you can further adjust weather & radar home to your wishes.

Radar film including forecast

View the next (default) or the past 90 minutes on the weather map as a weather animation.

Temperatures at every zoom level

The local temperatures are also displayed in the three largest zoom levels next to city names on the weather map.

Display wind arrows at intervals

Wind arrows are displayed on the main page for the next three day intervals.

Automatically adjust screen brightness

By default, the screen is illuminated less after sunset to protect your eyes and save energy. You can switch this off here. In this case, the manually selected brightness always remains set ([see page 14](#)).



Standby

Double-tap the display at any time to put the device into standby mode. To switch the device back on, simply touch the screen.

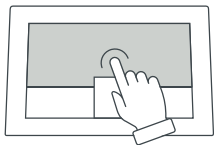

In the settings, under 'Display', you can define the time frame in which the device is supposed to be in standby mode.

See also [page 15](#) for further information.



Technical details

Display:	10.1-inch IPS
Screen resolution:	1280 x 800
Power supply:	AC adapter (included)
Connection:	USB-C
Cable length:	2 m (included)
Width:	250 mm
Height:	162 mm
Depth:	15 mm
Weight:	620 g

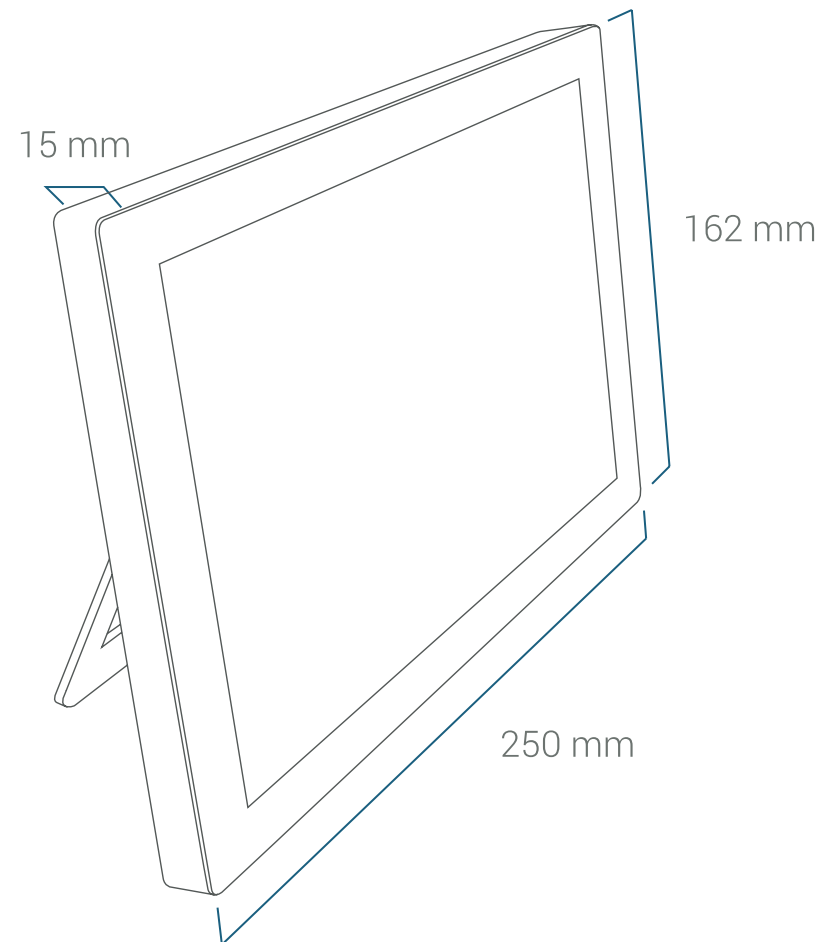

Note:
Only 2.4 GHz Wi-Fi networks with
WPA (2)- encoding are supported.

How to perform a reset

In case of unexpected problems, where the factory reset cannot be performed via the menu, you can reset the device to factory settings as follows:

1. Unplug the cable from the back of the weather display.
2. Place the device on a soft surface with the display pointing downwards.
3. Use a toothpick to gently push the reset button and hold after you hear a slight click. At the same time, plug the cable back into the back of the device and wait 10 seconds. Pull out the toothpick.
4. Set up the weather display. In the meantime, do not interrupt the power supply.

The display shows 'to be deleted'. The device then starts in the factory state and can be reconfigured.

Tip

If you need support or have further questions, please contact our service department at home@wetteronline.de



- The device should only be used in **closed spaces** with a surrounding temperature between **+5 and +35 °C**.
- Please **keep away from heat source (heaters, radiators, etc.)** and do **not expose** to permanent direct sunlight.
- Avoid heavy shaking or dropping your device.
- In case of damage to the housing, cable, or the power supply unit, after leakage of liquids or in the event of an unusual noise or odor development, take the device out of service and do not operate it.
- Use only a soft dry or damp cloth for cleaning. Do not use cleaning products or detergents.
- The device is not a toy.
- Please **only use the provided power supply unit** (5V DC / 2A). This must be fully exposed at all times during operation and must not be covered.
- Please do not **dispose of the device in regular garbage** but take it to a collection facility for small electrical appliances.
- With the **exception of the display film**, the **packaging can be completely disposed of as wastepaper**.

EU Declaration of Conformity

The product weather & radar home is compliant with all relevant harmonisation legislation of the European Union.

The full text of the EU Declaration of Conformity is available at

shop.wetteronline.de/compliance.

Manufacturer

weather&radar home

WetterOnline Meteorologische

Dienstleistungen GmbH

Karl-Legien-Str. 194a | 53117 Bonn

home@wetteronline.de